



for LIFE

Bulletin 204-E Metric

# LSWA/LRW/PMWA

## Closed Circuit Coolers

*Advanced Technology for the Future, Available Today*



Exclusive Thermal-Pak® Coil  
Z-725 Galvanized Steel Construction  
Totally Enclosed Fan and  
Pump Motors

CERTIFIED EN ISO 9001

# EVAPCO offers a variety of closed circuit coolers designs in

Each unit is a reflection of Evapco's commitment to excellence in engineering and manufacturing. An emphasis on research and development has resulted in many cooler innovations.

## All Evapco coolers have the following features as standard:

- Patented\* Thermal-Pak® Coil resulting in the maximum thermal performance available per plan area.
- Heavy Gauge Hot Dip Galvanized Steel construction assuring long operating life.
- Totally Enclosed Fan and Pump Motors.

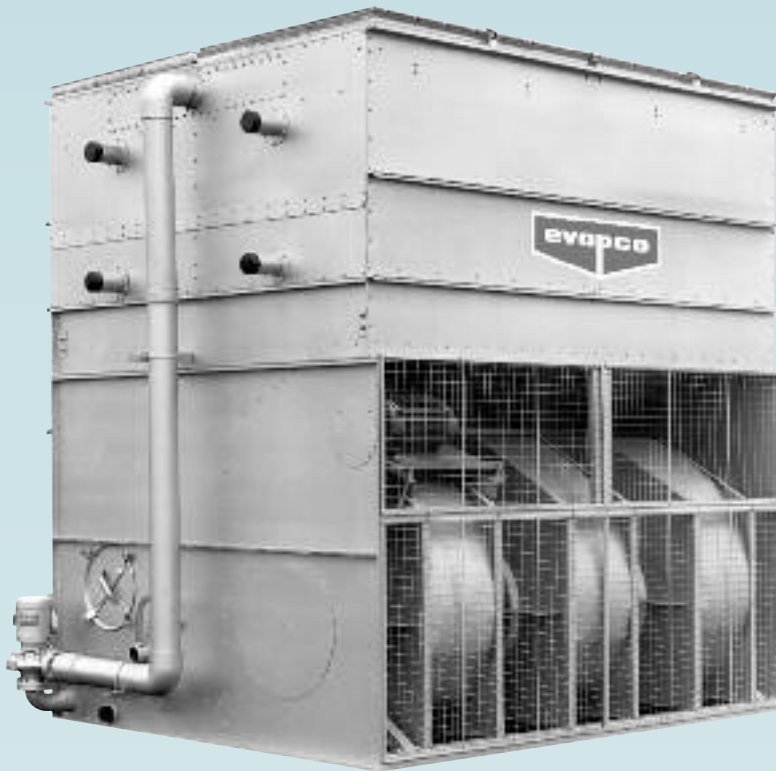

### LSWA Series

LSWA centrifugal fan forced draft coolers are recommended for a wide range of applications. LSWA models are very quiet and ideal for applications where noise is a concern. In addition, sound attenuation packages are available to further reduce the sound levels.

The centrifugal fans can also operate against the static pressure loss of ductwork and are suitable for indoor installations, or those with inlet or outlet ductwork. Very quiet operation.

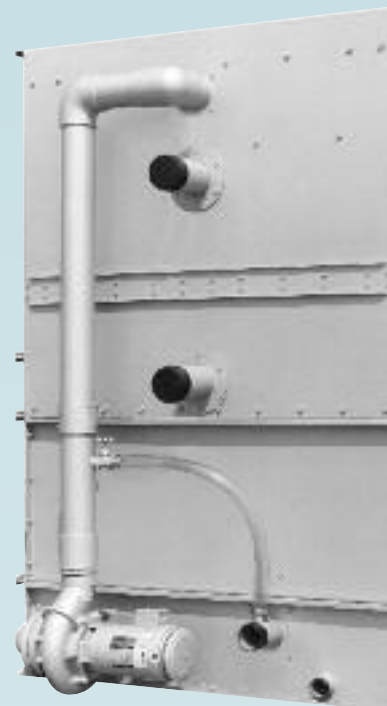

### LRW Series

LRW coolers are forced draft, centrifugal fan models designed specifically for applications requiring low height. Their compact, yet user-friendly design makes them ideal for smaller applications.



# numerous sizes to accommodate almost any application.

- Stainless Steel Suction Strainers easily removed for periodic cleaning.
- Proven Performance, Industrial Design and Quality Construction for years of Dependable Service.
- Evapco's Commitment to 100% Customer Satisfaction.

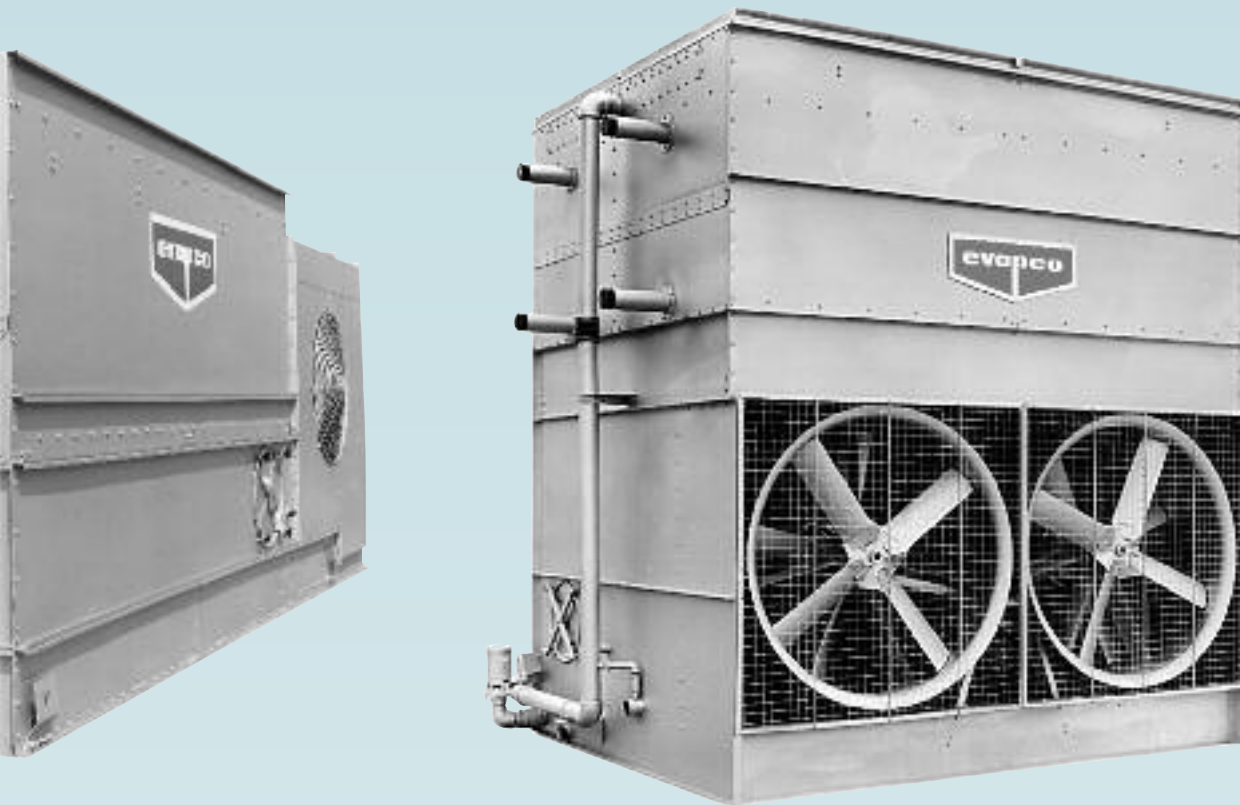

*LRW Design features include:*

- Low Silhouette
- Low Maintenance
- Low Rigging Costs
- Low Sound

## PMWA Series

PMWA Models are forced draft, with axial flow fans.

The effective axial flow fans can reduce power requirements by up to 50% over centrifugal fan models of similar capacity.

Low energy consumption.

**For other EVAPCO Cooler Models See:**

**ATW Series Induced Draft Counterflow Design**



Since its founding in 1976, EVAPCO Inc. has become a world-wide leader in supplying quality equipment to the Industrial Refrigeration HVAC and Process Cooling Industries.

EVAPCO's success has been the result of a continual commitment to product improvement, quality workmanship and a dedication to providing unparalleled service.



An emphasis on research and development has lead to many product innovations – a hallmark of EVAPCO through the years.

The ongoing R & D Program enables EVAPCO to provide the most advanced products in the industry – technology for the future, available today.

With 16 facilities in seven countries and over 160 sales offices in 42 countries world-wide, EVAPCO is ready to assist in all your evaporative cooling needs.

## Owner Advantages

### Patented Thermal-Pak® Coil

EVAPCO's patented Thermal-Pak® cooling coils feature a design which assures maximum cooling capacity. The airflow thru the coil is counterflow to the fluid flow, providing the most efficient heat transfer. This special coil design is utilized to reduce the air pressure drop through the unit while maximizing tube surface area and increasing its heat transfer capabilities. The uniquely shaped tubes of the coil are staggered in the direction of air flow to obtain a high film coefficient. In addition, all tubes are pitched in the direction of fluid flow to give good liquid drainage.

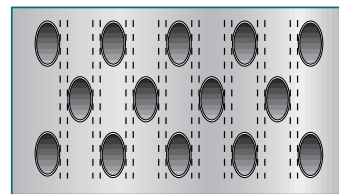

Thermal-Pak® Coil by EVAPCO

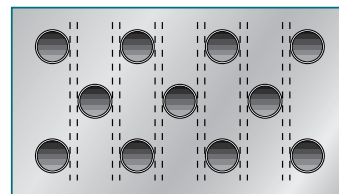

Round Tube Coil by Others

The coils are manufactured from high quality steel tubing following the most stringent quality control procedures. Each circuit is inspected to assure the material quality and then tested before being assemble into a coil. Finally, the assembled coil is air pressure tested under water in accordance with the "Pressure Equipment Directive" (PED) 97/23/EC.

To protect the coil against corrosion, it is placed in a heavy-duty steel frame and the entire assembly is dipped in molten zinc (hot dip galvanized) at a temperature of approximately 430°C).



Thermal-Pak® Coil

U.S. Patent No. 4,500,330



## EVAPCOAT Corrosion Protection System: The Standard for Closed Circuit Coolers

EVAPCO, long known for using premium materials of construction, has developed the ultimate system for corrosion protection in galvanized steel construction – the EVAPCOAT Corrosion Protection System. Marrying corrosion free materials with heavy gauge mill hot-dip galvanized steel construction to provide the longest life product with the best value.

### Z-725 Mill Hot-Dip Galvanized Steel Construction

Mill hot-dip galvanized steel has been successfully used for over 25 years for the protection of closed circuit cooler against corrosion. There are various grades of mill galvanized steel each with differing amounts of zinc protection. EVAPCO has been a leader in the industry in developing heavier galvanizing, and was the first to standardize on Z-725 mill hot-dip galvanized steel.

Z-725 designation means there is a minimum of 725 g of zinc per sqm of surface area as measured in a triple spot test. Z-725 is the heaviest level of galvanizing available for manufacturing closed circuit cooler and has a minimum of 165% more zinc protection than competitive designs using Z-275 steel.

During fabrication, all panel edges are coated with a 95% pure zinc-rich compound for extended corrosion resistance.

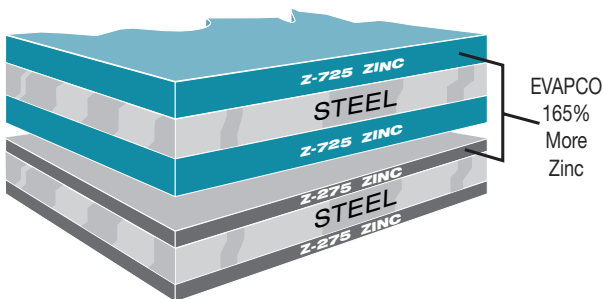

### Type 304 Stainless Steel Strainers

Subjected to excessive wear and corrosion, the sump strainer is critical to the successful operation of the cooler. EVAPCO uses only stainless steel for this very important component.

### PVC Drift Eliminators

The final elements in the upper part of the closed circuit cooler are moisture eliminators which strip the entrained water droplets from the leaving air stream.

EVAPCO eliminators are constructed entirely of inert, corrosion-free PVC. This PVC material has been specially treated to resist damaging ultraviolet light. The eliminators are assembled in easily handled sections to facilitate removal thereby exposing the upper portion of the unit and water distribution system for periodic inspection.

### PVC Water Distribution System

Another important part of an closed circuit cooler is the water distribution system. In order to give the maximum heat transfer and minimize scaling, the coil must be drenched with water at all times. The EVAPCO system does this by circulating approximately 4 l/s over every square meter of coil surface area.

The water distribution system is greatly simplified in EVAPCO units, with the largest non-clog ZM water diffusers available for closed circuit coolers. The ZM diffusers are threaded into the water distribution header to ensure correct positioning. Also, a collar on the diffuser extends into the header and acts as an anti-sludge ring to reduce the need for maintenance. Excellent flooding of the coil is maintained at all times without numerous small orifice nozzles. For corrosion protection the ZM diffusers are made of heavy-duty, glass reinforced nylon for long life and 100% corrosion resistance. Distributor pipes are non-corrosive Polyvinyl Chloride (PVC).



ZM Spray Nozzle

### Totally Enclosed Motors

EVAPCO uses totally enclosed motors for all fan and pump motors as standard. These superior motors help to assure longer equipment life without motor failures, which result in costly downtime.

### Alternate Materials of Construction

For particularly corrosive environments, EVAPCO coolers are available with Type 304 Stainless Steel construction for basins and/or casings. Model LRW coolers are provided with type 304 stainless steel basins as standard equipment. Contact the factory for details on available options.

# LSWA & LRW Design and Construction Features

The LSWA and LRW units are a result of EVAPCO's extensive experience in forced draft centrifugal fan designs. Both models are designed for easy maintenance and long, trouble free operation.

### Efficient Drift Eliminators

- Advanced design removes mist from leaving airstream.
- Corrosion resistant PVC for long life.

### Exclusive Thermal-Pak® Coil

- Providing Maximum Efficiency per Plan Area

### Double-Brake Flange Joints

- Stronger than single-brake designs by others.
- Minimizes water leaks at field joints.
- Greater structural integrity.

### Z-725 Heavy Mill-Dip Galvanized Steel Construction

- (Stainless steel available as affordable option)

### Totally Enclosed Pump Motors

- Long, trouble-free operation.

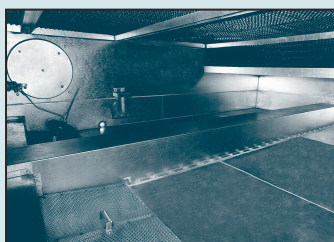

### Stainless Steel Strainers

- Resists corrosion better than other materials.

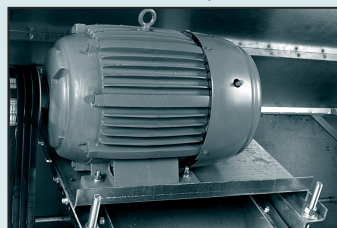

### Totally Enclosed Fan Motors

- Assures long life
- All normal maintenance can be performed quickly from outside the unit.
- If required, motor may be easily removed.



## The superior design offers:

- Low Rigging Costs • Low Installed Costs
- Low Silhouette • Low Maintenance • Low Sound

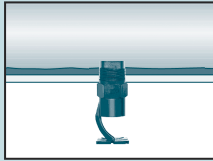

### PVC Spray Distribution Header with ZM Nozzles

- Nozzles are threaded to assure proper orientation.
- “Anti-Sludge Ring” reduces maintenance.
- Large orifice nozzles prevent clogging.
- Threaded end caps for ease of cleaning.

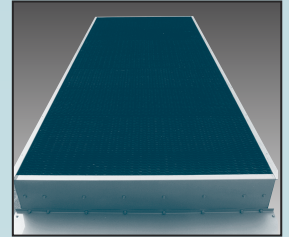
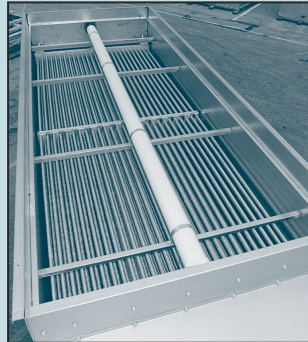
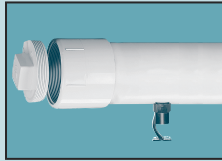

### Efficient Drift Eliminators

- Advanced design removes mist from leaving airstream.
- Corrosion resistant PVC for long life.

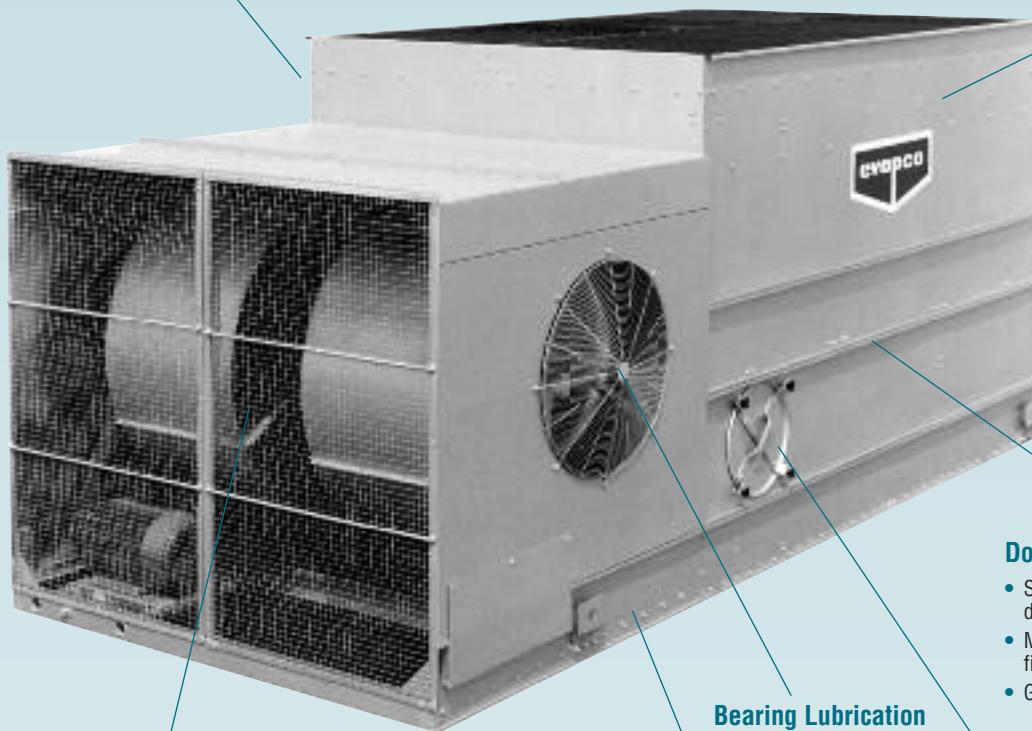

### Z-725 Heavy Mill-Dip Galvanized Steel Construction

(Stainless steel available as affordable option)

### Double-Brake Flange Joints

- Stronger than single-brake designs by others.
- Minimizes water leaks at field joints.
- Greater structural integrity.

### Bearing Lubrication

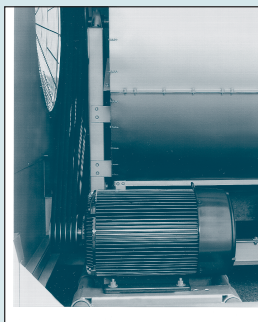

### Easy to Service Motor Mount Design

- All normal maintenance can be performed quickly from outside the unit.
- If required, motor may be easily removed.
- Split fan housings allow removal of all mechanical equipment through the end of the unit.

### Stainless Steel Basin

- Standard Construction
- Eliminates the need for unreliable epoxy coatings.

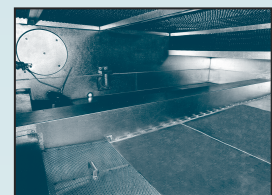

### Stainless Steel Strainers

- Resists corrosion better than other materials.

## Forced Draft Centrifugal Design Features LSWA & LRW Models

### Application versatility

Centrifugal units are recommended for a wide range of installations. They are quiet, can easily be hidden, and the increase in fan motor kW over propeller fan units is generally not significant in the small size range. They are also excellent for larger installations where very quiet operation is a must, such as residential neighborhoods.

In addition, centrifugal fan units can operate against the static pressure loss of ductwork and are therefore ideal for indoor installations.



### Centrifugal Fan Assembly

Fans on LSWA & LRW coolers are of the forward curved centrifugal design with hot-dip galvanized steel construction. All fans are statically and dynamically balanced and are mounted in a hot-dip galvanized steel housing designed and manufactured by EVAPCO.

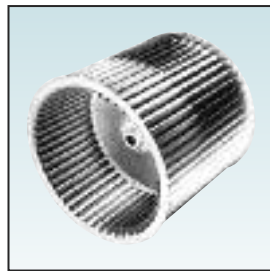

Centrifugal Fan

### Very Quiet Operation

Centrifugal fan units operate at lower sound levels which make this design preferred for installations where noise is a concern. The sound they produce is primarily at high frequencies which is easily attenuated by building walls, windows, and natural barriers. Additionally, since the sound from the fans is directional, single sided air entry models can be turned away from critical areas avoiding a sound problem. When even quieter operation is necessary, centrifugal fan models can be equipped with optional sound attenuation packages. Consult the factory for details.

### Capacity Control Dampers

Capacity control dampers are an excellent way to match unit capacity to system requirements. This option consists of dampers mounted in the air stream which modulate the air flow through the unit. They may also be supplied with an electric control package.

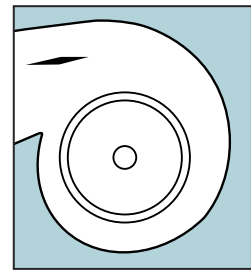

Fan Dampers



## Fan Motor Mount

Fan motors are mounted in a convenient open area to make it easy to adjust belt tension, lubricate the motor, electrically connect it, or change the motor if necessary. The fan motor and drive are under a protective cover for safety and to protect them from the elements.

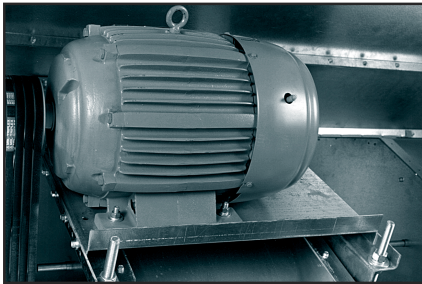

LSWA Fan Motor Mount

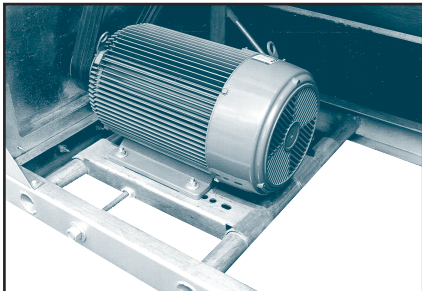

LRW Fan Motor Mount

## Accessibility

The basin/fan section of a centrifugal fan unit is designed for accessibility and ease of maintenance. Fan and drive components are positioned to allow easy adjustment and cleaning. All grease fittings are in convenient locations for periodic lubrication.

Large circular access doors are provided on each section to allow entry into the basin. All float valve and strainer assemblies are located near the door for easy adjustment and cleaning. The basin sump is designed to catch the dirt accumulated and can be flushed out simply with a hose. The basin strainers may be easily removed for periodic cleaning.

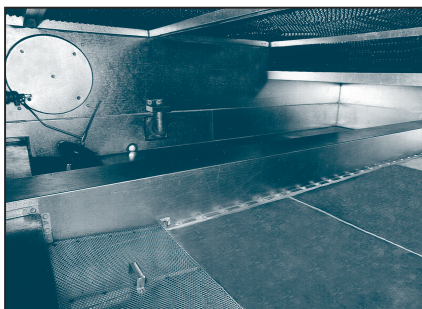

## Reduced Height and Improved Maintenance Accessibility

The LRW unit has been designed to satisfy installation requirements where height limits must be observed. The lower profile design of the LRW does not, however, sacrifice maintenance accessibility for reduced height. Its unique casing design allows the water distribution system, cold water basin, fan section and other unit components to be easily maintained.

Small, light weight sections of the drift eliminators can be easily removed to access the water distribution system. Large circular access doors are located on both sides of the cold water basin to allow adjustment of the float assembly, removal of the stainless steel strainers and cleaning of the basin. The fan motor and drive system are located at one end of the unit and are completely accessible by removing the inlet screens. Although, routine maintenance can be performed from the exterior of the unit without removing the inlet screens

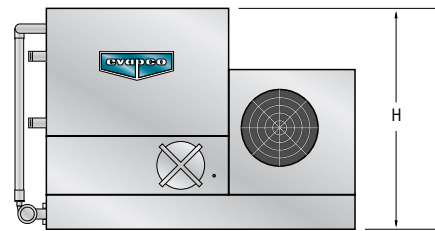

## Low Installed Costs

The compact, unitary design of the LRW units allows them to be shipped completely assembled. This results in lower transportation costs and no assembly requirements at the job site. Note: Options such as sound attenuation and discharge hoods will require additional lifts and some minor assembly.

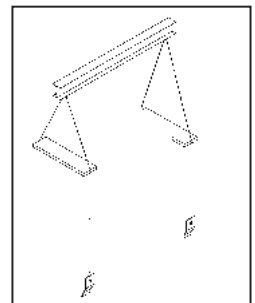

## Transport of a Pre-Assembled Unit

The LRW ships fully assembled. This means lower transport costs and no further expenses at the job site for assembly. LRW units are ideal for truck-mounted applications for remote sites or temporary installations.

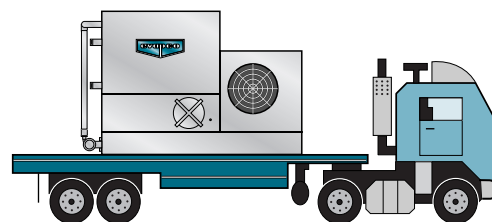

## Forced Draft Axial Fan Design Features - PMWA Models

### Energy Efficient for Lowest Operating Cost

#### Cut Operating kW up to 50%

The Power-Mizer models use effective axial flow fans which can reduce power requirements by up to 50%. This results in significant energy savings.



### Vane Axial Fan Assembly

The PMWA models utilize two stage vane-axial fans for highly efficient operation. The fans are installed in a closely fitted cowl with a venturi inlet and advanced design guide vanes between stages, which help direct the flow and increase efficiency.

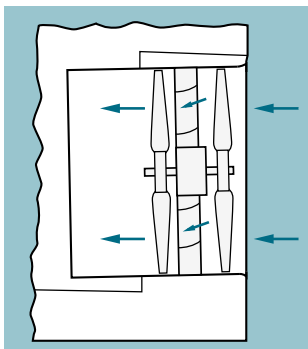

*Two Stage Fan*

### Cast Aluminum Alloy Fans

The fans are heavy-duty cast aluminum alloy that are virtually corrosion free.

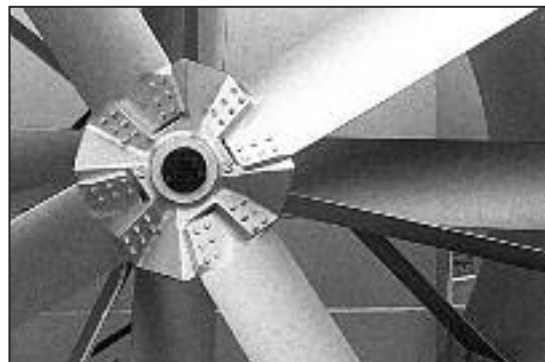

*Vane-Axial Fan*



### PMWA Fan Motor Mount

EVAPCO's tandem TEFC motor mount assembly allows for two fans to be operated with one motor for simplicity. Routine maintenance is easily performed. If redundancy is a concern, individual fan motor drives are available as an option on PMWA models.



*Tandem Fan Drive Motor Mount*

### Accessibility

The fan section is completely open and accessible at waist level where each part may be carefully checked by simply removing the safety screens.

Bearing grease fittings are extended to the outside of the unit to ease of lubrication.

The basin is also open and easy to access for inspection or cleaning. There is a depressed sump area to catch the dirt accumulated and it may be easily flushed out with a hose through the access door on either end.

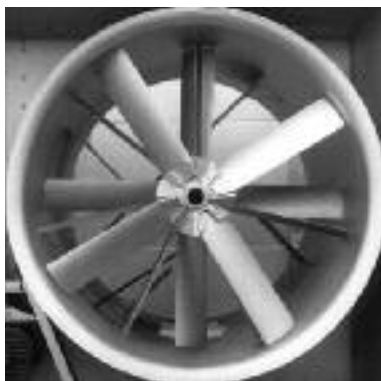

*Vane-Axial Fan*

### Internal Baffles

As a standard feature, all EVAPCO coolers with multiple motors are provided with an internal baffle system which extends from the pan bottom vertically through the coil bundle. This allows the user to cycle fan motors independently to match system load without the harmful effects of air by-pass.

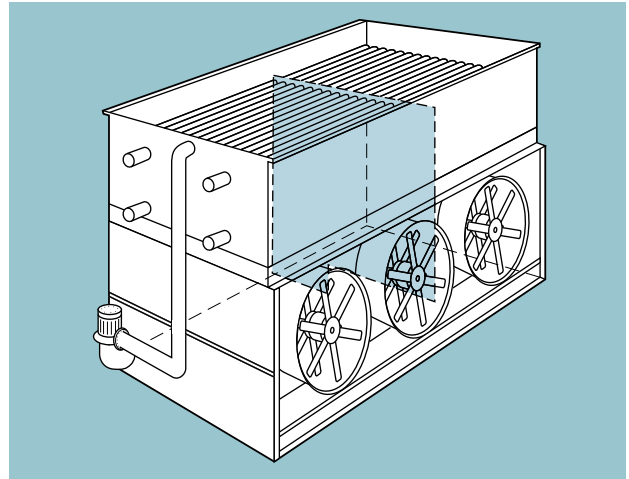

*Internal Baffles*

### Power-Band Drive

The Power-Band drive is a solid backed belt system that has a high lateral rigidity. This eliminates the problem of mismatched belts and prevents belts from jumping pulleys, a common problem with other designs.

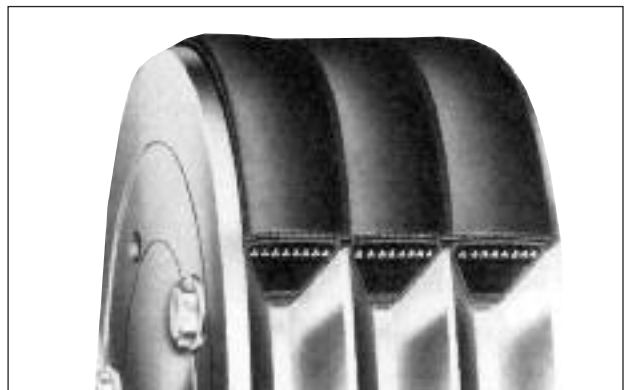

*Power-Band*

## Optional Equipment for Closed Circuit Coolers

### Two Speed Motors

Two speed fan motors can provide an excellent means of capacity control. In periods of lightened loads or reduced wet bulb temperatures, the fans can operate at low speed, which will provide about 60% of full speed capacity, yet consume only about 15% of the power compared with high speed. In addition to the energy savings, the sound levels of the units will be greatly reduced at low speed.

### LSWA & LRW Models

#### Capacity Control Dampers & Pony Motors

In addition to two speed fan motors, variable frequency drives (VFD's) or cycling fan motor on multiple motor units, centrifugal fan coolers have two other types of capacity control options available to them: Pony motors and capacity control fan dampers.

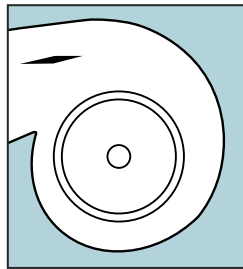

*Fan Dampers*

Pony motors utilize a smaller fan motor in conjunction with the primary motor for use in times of reduced loading. This pony motor is typically 1/4 the kW of the primary motor, and can significantly reduce energy requirements.

A feature of the centrifugal fan unit is the availability of capacity control dampers. These dampers are located directly in the fan housings and control water temperature over a modulating range of 3°C. When the dampers approach their closed position, an end switch shuts off the fan motor. Dampers are recommended where it is necessary to control temperature closely and there is a rapidly fluctuating load.

#### Basin Heater Package

If a remote sump configuration is not practical, electric basin heater packages are available to help prevent freeze-up of the basin water. The packages include electric heater elements with thermostat and low water cutoff. (See page 21 for heater size and application)

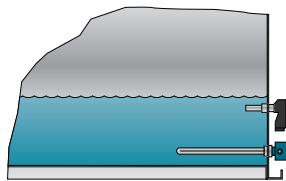

### Electric Water Level Control

EVAPCO closed circuit coolers are available with an optional electric water level control system in place of the standard mechanical makeup valve and float assembly. This package provides very accurate control of the pan water level and does not require field adjustment, even under widely variable operating conditions.

The control was designed by EVAPCO and consists of multiple heavy duty stainless steel electrodes. These electrodes are mounted external to the unit.

The weather protected slow closing solenoid valve for the makeup water connection is factory supplied and is ready for piping to a water supply with a pressure between 140 kPa (minimum) and 340 kPa (maximum).

### Extended Surface Coil

Closed Circuit Coolers can be provided with spiral fins on the heat exchanger coil to increase the dry performance of the unit. Dry performance is accomplished by rejecting heat to the atmosphere without the use of the spray pump and the cooling process. Dry operation can be practical in cold climates and/or when reduced winter loads exist. The number of fins per inch and quantity of rows finned can be varied to obtain different dry performances. Dry operation often requires the next larger size fan motor. Consult the factory for sizing.

### Solid Bottom Panels for Ductwork

When centrifugal fan units are installed indoors and intake air is ducted to the unit, a solid bottom panel is required to completely enclose the fan section and prevent the unit from drawing room air into the fan intakes. When this is ordered, air inlet screens are omitted and the fan bearings are provided with extended lubrication fittings to facilitate maintenance from outside the duct.

### Access Ladders

Access ladders are available to provide access for water distribution system inspection and maintenance.

### Stainless Steel Basin (Option)

LSWA and PMWA coolers are available with an inexpensive all stainless steel basin section. This provides superior corrosion resistance over other materials of construction. (Standard on all LRW models)



## Optional Equipment for Sound Reduction

### LSWA & LRW Models

#### Sound Attenuation Packages

The centrifugal fan design of the LSWA and LRW models operate at lower sound level which make these units preferred for installations where noise is a concern. The sound they produce is primarily at high frequencies which is easily attenuated by building walls, windows and natural barriers. For extremely noise sensitive applications, the LSWA and LRW centrifugal fan models may be supplied with various stages of intake and/or discharge attenuation packages which greatly reduce sound levels.

The sound attenuation options can be provided in stages to provide varying degrees of attenuation while economically matching the project sound requirements.

Oversize fan motors are required for many of these options in order to overcome the additional static pressure. Consult the factory for Certified Sound Data for each sound attenuation option.

#### Fan Side Inlet Attenuation (LRW only)

Reduces sound radiated from the fan side air intakes and has an open bottom to allow for air entry. This attenuation package ships loose to be mounted in the field on each side of the cooling tower over the fan intakes.

#### Fan End Inlet Attenuation (LSWA and LRW)

Reduces sound radiated through the end air intakes. It consists of baffled panels to change the path of the air entry and to capture the radiated noise thus reducing the overall sound levels generated. In addition, the external belt adjustment mechanism is extended through the inlet attenuator to allow easy belt adjustment without having to enter the unit.

#### Discharge Attenuation (LSWA and LRW)

The discharge attenuation hood features a straight sided design with insulated baffles to reduce the overall sound levels of the discharge air. The discharge attenuation incorporates a large access panel to allow entry to the drift eliminators and water distribution system. If a higher discharge velocity is required with minimal sound attenuation, a tapered discharge hood is available.

### PMWA Models

#### Wide Blade Fans

Wide blade fans are available for PMWA forced draft units. The cast aluminum fans operate at lower tip speeds to significantly reduce sound levels.

#### Discharge Attenuation

(LSWA and LRW)

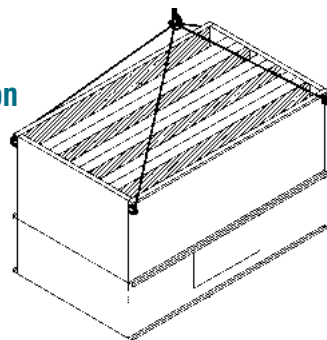

#### Fan End Inlet Attenuation

(LSWA and LRW)

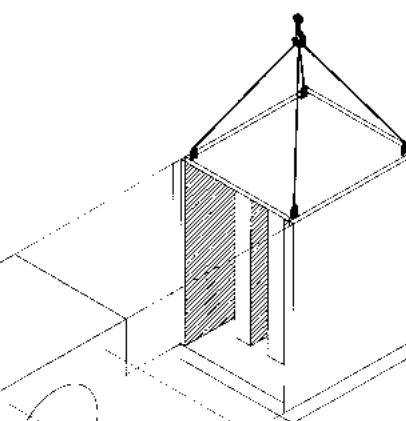

#### Fan Side Inlet Attenuation

(LRW only)

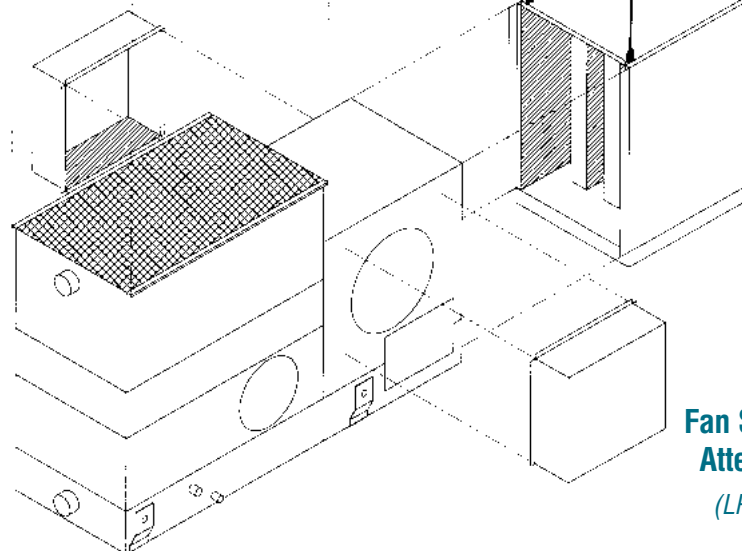

# Engineering Dimensions & Data

## Centrifugal Fan Models LSWA 91A to 91D, LSWA 135A to 135D, LSWA 182A to 182D, LSWA 270A to 270D

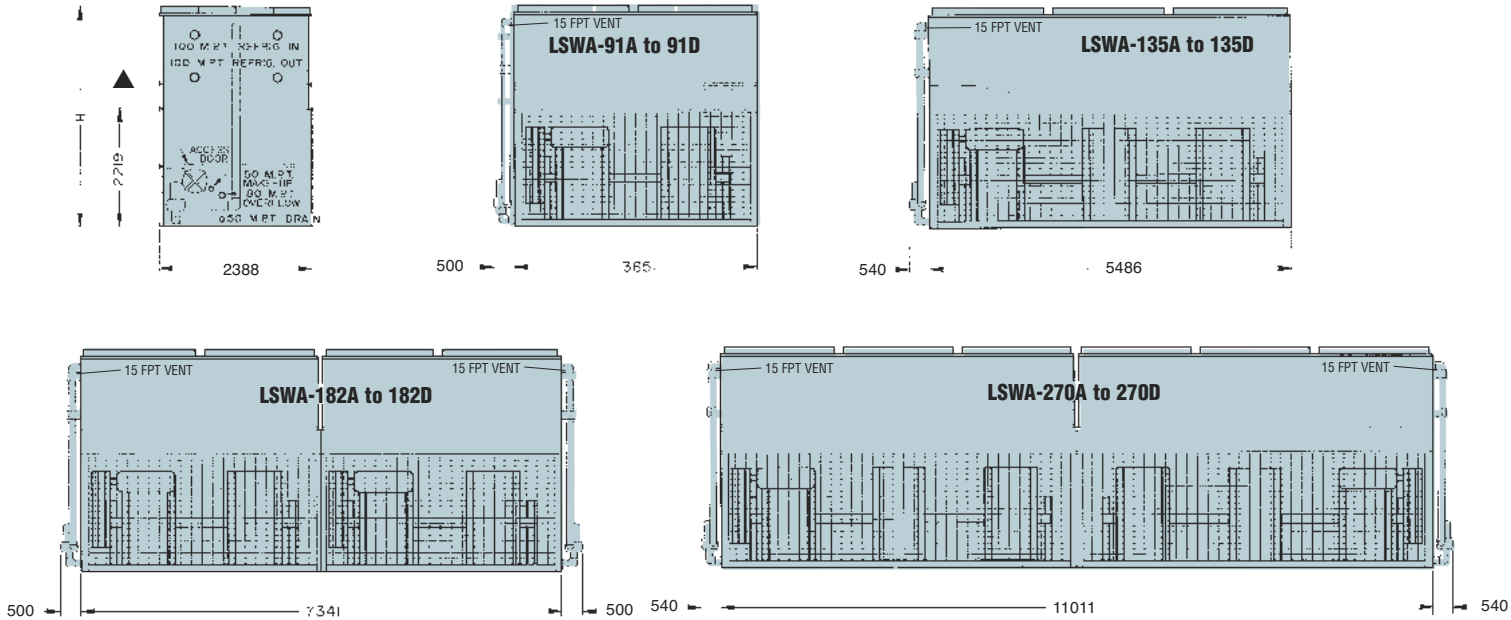

▲ NOTE: Coil connection(s) and other unit dimensions may vary to match application requirements and/or shipping regulations. Consult the EVAPCO plant or certified drawings for detailed information.

NOTE: All piping connections are nominal bore sizes in mm. The number of coil connections doubles when flow rate exceeds 56 l/s on Models 91A thru 135D and 112 l/s on Models 182A thru 270D.

**TABLE 4 Engineering Data**

UNIT N°	WEIGHTS (kg)			FANS		SPRAY PUMP		REMOTE SUMP		Coil Volume Liters	DIMENSIONS (mm)	
	Shipping	Operating	Heaviest section†	kW*	m³/s	kW	l/s	Liters Req'd**	Conn. Size		Height	Length
<b>LSWA- 91A</b>	4840	7460	3195	18,5	24,7	4,0	36,0	1361	250	816	3359	3651
<b>91B</b>	5660	8575	3980	22,0	25,7	4,0	36,0	1361	250	1081	3549	3651
<b>91C</b>	6480	9675	4460	30,0	27,7	4,0	36,0	1361	250	1338	3740	3651
<b>91D</b>	7265	10750	5545	30,0	27,2	4,0	36,0	1361	250	1603	3930	3651
<b>LSWA- 135A</b>	7025	10935	4680	30,0	37,7	5,5	53,0	2003	300	1217	3359	5486
<b>135B</b>	8225	12570	5880	30,0	37,0	5,5	53,0	2003	300	1610	3549	5486
<b>135C</b>	9400	14175	7025	37,0	39,0	5,5	53,0	2003	300	1827	3740	5486
<b>135D</b>	10575	15780	8200	37,0	38,2	5,5	53,0	2003	300	2397	3930	5486
<b>LSWA- 182A</b>	9680	14920	3195	(2) 18,5	49,3	(2) 4,0	72,0	2722	250	1633	3359	7341
<b>182B</b>	11320	17150	3980	(2) 22,0	51,4	(2) 4,0	72,0	2722	250	2162	3549	7341
<b>182C</b>	12960	19350	4460	(2) 30,0	55,2	(2) 4,0	72,0	2722	250	2676	3740	7341
<b>182D</b>	14530	21500	5545	(2) 30,0	54,3	(2) 4,0	72,0	2722	250	3205	3930	7341
<b>LSWA- 270A</b>	14050	21870	4680	(2) 30,0	75,5	(2) 5,5	106,0	4007	300	2434	3359	11011
<b>270B</b>	16450	25140	5880	(2) 30,0	74,0	(2) 5,5	106,0	4007	300	3221	3549	11011
<b>270C</b>	18800	28350	7025	(2) 37,0	78,1	(2) 5,5	106,0	4007	300	4007	3740	11011
<b>270D</b>	21150	31560	8200	(2) 37,0	76,5	(2) 5,5	106,0	4007	300	4793	3930	11011

† Heaviest section is the coil section.

\* For external static pressure up to 125 Pa., use next larger size fan motor.

\*\* Liters shown is water in suspension in unit and piping. Allow for additional water in bottom of remote sump to cover pump suction and strainer during operation (300 mm would normally be sufficient).

Dimensions are subject to change. Do not use for pre-fabrication.

# Application

## Design

Evapco units are heavy-duty construction and designed for long trouble-free operation. Proper equipment selection, installation and maintenance is, however, necessary to ensure good unit performance. Some of the major considerations in the application of a closed circuit cooler are presented below. For additional information, contact the factory.

## Air Circulation

In reviewing the system design and unit location, it is important that proper air circulation be provided. The best location is on an unobstructed roof top or on ground level away from walls and other barriers. Care must be taken when locating coolers in wells or enclosures or next to high walls. The potential for recirculation of hot, moist discharge air back into the fan intake exists. Recirculation raises the wet bulb temperature of the entering air causing the leaving fluid temperature to rise above the design. For these cases, a discharge hood or ductwork should be provided to raise the overall unit height even with the adjacent wall, thereby reducing the chance of recirculation. Good engineering practice dictates that the closed circuit coolers discharge air not be directed or located close to or in the vicinity of building air intakes. Engineering assistance is available from the factory to identify potential recirculation problems and recommend solutions.

For additional information see Evapco Bulletin entitled "Equipment Layout".

## Structural Steel Support

The recommended method of support for EVAPCO coolers is two structural "I" beams located under the outer flanges and running the entire length of the unit. Mounting holes 19mm in diameter, are located in the bottom channels of the pan section to provide for bolting to the structural steel; refer to certified drawings from the factory for bolt hole locations. Beams should be level to within 1.7 mm per meter before setting the unit in place. Do not level the unit by shimming between it and the "I" beams as this will not provide proper longitudinal support.

## Vibration Isolation

The fans on EVAPCO units are balanced and run virtually vibration free. In addition, the rotating mass is very small in relation to the total mass of the closed circuit coolers, further reducing the possibility of objectionable vibration being transmitted to the building structure. As a result, vibration isolation is generally not required. In those cases where it is determined that vibration isolation is necessary, spring type vibration isolator rails can be furnished. The rails are constructed of heavy gauge Z-725 hot-dip galvanized steel for superior corrosion resistance. Rails are designed to be mounted between the closed circuit cooler and the supporting steel framework. They are 90% efficient and have approximately 25 mm static deflection. Rails are designed for wind loading up to 80 km/hr.

It is important to note that vibration isolation must be installed continuously along the full length of the closed circuit cooler on both sides of the unit. Point isolators may be used between the supporting steel and the building framework, but not between the unit and the supporting steel.

## Indoor Installations

Centrifugal fan models can be installed indoors where it is desirable to hide the unit or where it is the only location available. Discharge ductwork is required for these installations. Normally it is best to use the room as a plenum for inlet air, but inlet ductwork can be used if required.

The design of ductwork should be symmetrical to provide even air distribution across both intake and discharge openings. The static pressure loss imposed by the ductwork must not exceed 125 Pa. Care must be taken to provide large access doors in the ductwork for accessibility to the unit fan section, eliminators and water distribution system for normal maintenance.

The centrifugal fan cooler can handle the external static of ductwork by using the next larger size fan motor. Units installed with inlet ductwork should also be ordered with the solid bottom panel option. Drawings are available from the factory showing size and location of duct connections.

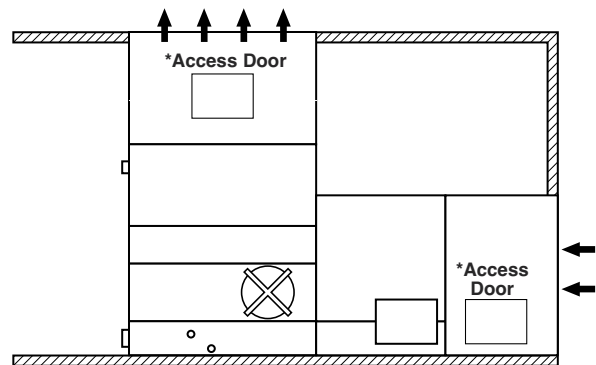

## Maintaining the Recirculated Water System

The heat rejection in a cooler is accomplished by the evaporation of a portion of the recirculated spray water. As this water evaporates, it leaves behind all of its mineral content and impurities. Therefore, it is important to bleed-off an amount of water equal to that which is evaporated to prevent the build-up of these impurities. If this is not done, the mineral or the acidic nature of the water will continue to increase. This will ultimately result in heavy scaling or a corrosive condition.



## Applications

### Bleed-off

Each unit supplied with a pump mounted on the side is furnished with a clear bleed line for visual inspection and a valve which, when fully open, will bleed-off the proper amount of water. If the make-up water supplying to the unit is relatively free of impurities, it may be possible to cut back the bleed, but the unit must be checked frequently to make sure scale is not forming. Make-up water pressure should be maintained between 140 and 340 kPa.

### Water Treatment

In some cases the make-up will be so high in mineral content that a normal bleed-off will not prevent scaling. In these cases water treatment will be required and a reputable water treatment company familiar with the local water conditions should be consulted.

Any chemical water treatment used must be compatible with the galvanized construction of the unit. If acid is used for treatment, it should be accurately metered and the concentration properly controlled. The pH of the water should be maintained between 6.5 and 8.0. Units constructed of galvanized steel operating with circulating water having a pH of 8.3 or higher will require periodic passivation of the galvanized steel to prevent the formation of "white rust". Batch chemical feeding is not recommended because it does not afford the proper degree of control. If acid cleaning is required extreme caution must be exercised and only inhibited acids recommended for use with galvanized construction should be used. For more information see EVAPCO Bulletin entitled "Maintenance Instructions".

### Control of Biological Contamination

Water quality should be checked regularly for biological contamination. If biological contamination is detected, a more aggressive water treatment and mechanical cleaning program should be undertaken. The water treatment program should be performed in conjunction with a qualified water treatment company. It is important that all internal surfaces be kept clean of accumulated dirt and sludge. In addition, the drift eliminators should be maintained in good operating condition.

**Note: The location of the closed circuit cooler must be considered during the equipment layout stages of a project. It is important to prevent the discharge air (potential of biological contamination) from being introduced into the fresh air intakes of the building.**

### Recirculating Water System - Freeze Protection

Water lines to and from the unit, spray pump and related piping should be heat traced and insulated up to the overflow level in order to protect from freezing.

The unit should not be operated dry (fans on, pump off) unless the basin is completely drained and the unit has been designed for dry operation.

### Pan Freeze Protection

#### REMOTE SUMP

Whenever a cooler is idled during subfreezing weather, the water in the sump must be protected from freezing and damaging the pan. The simplest and most reliable method of accomplishing this is with a remote sump tank located in a heated space in the building under the cooler. The recirculating water pump is mounted at the remote sump and whenever it is shut-off, all of the water drains into the indoor tank. When a cooler is ordered for remote sump operation, the standard float valve and strainer are omitted, and the unit is provided with an oversized bottom water outlet connection. Where a remote sump is not possible, a supplementary means of heating the pan water must be provided.

#### ELECTRIC HEATERS

Electric immersion heaters are available factory installed in the basin of the cooler. They are sized to maintain a +4 or +5°C pan water temperature with -18°C ambient air temperature with the fans and pumps off. They are furnished with a thermostat and low water protection device to cycle the heater on when required and to prevent the heater elements from energizing unless they are completely submerged. Components are enclosed in rugged, weatherproof enclosures for outdoor use. The heater power contactors and electric wiring are not included as standard.

### Electric Pan Heaters

Model No.	kW*
LSWA 20AA to 20C	2
LSWA 30A to 30C	3
LSWA 41A to 41C	3
LSWA 58A to 58D	4
LSWA 87A to 87D	(2) 3
LSWA 91A to 91D	5
LSWA 116A to 116D	8
LSWA 135A to 135D	(2) 4
LSWA 174A to 174D	(2) 5
LSWA 182A to 182D	(2) 5
LSWA 232A to 232D	(2) 8
LSWA 270A to 270D	(2) 10
LSWA 348A to 348D	(2) 10
LRW 18-2E to 18-5H	2
LRW 30-2G to 30-5H	3
LRW 45-3I to 45-6J	4
LRW 60-3K to 60-6M	6
LRW 72-3K to 72-5L	7
LRW 96-4L to 96-6N	9
PMWA 116A to 116D	8
PMWA 174A to 174D	(2) 6
PMWA 232A to 232D	(2) 8
PMWA 348A to 348D	(4) 6

\* Electric heater selection based on -18°C ambient temperature. For alternate low ambient heater selections, consult the factory.

## Optional Equipment

### Discharge Hoods with Positive Closure Dampers (LSWA-LRW)

When a closed circuit cooler is used in a water-to-air heat pump system or in certain process cooling applications, a method of reducing the heat loss during idle periods of wintertime operation may be required. For these cases, an optional discharge hood with positive closure dampers and damper actuator is available.

The discharge hood with dampers is designed to minimize the heat loss from convective airflow through an idle cooler. Further reductions in heat loss may be obtained with the addition of insulation to the hood and casing, minimizing conductive heat losses. Insulation may be factory installed on the hood and casing or field installed by an insulation contractor.

The discharge hood and dampers are constructed of hot-dip galvanized steel. Hoods are equipped with access panels to facilitate maintenance on the eliminators and water distribution system. The dampers, damper actuator and linkage are all factory assembled. Actuator controls and wiring are field supplied by others. Damper actuators require 230 Volt power supply.

The system control sequence should provide for dampers to be fully open before the fans are running and closed when the fans are off; the damper actuator must be interlocked with the temperature control system for this purpose. When a centrifugal fan model uses a tapered discharge hood, the next larger size fan motor must be used to overcome the additional static pressure.

Heat loss data is provided for standard units without hoods, with hoods and with hoods and insulation. Table ratings are based on 10°C water in the coil, -23°C ambient and 70 km/hr winds (fan and pump off).

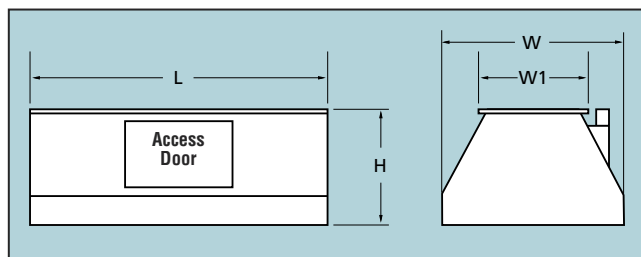

Tapered Discharge Hood

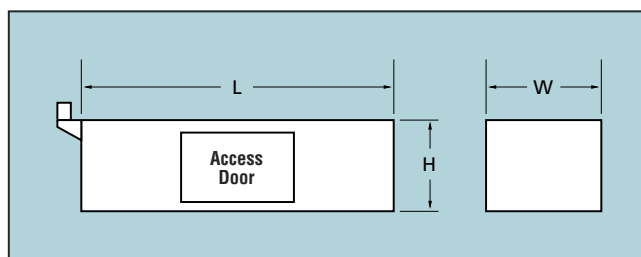

Straight-Sided Discharge Hood

### Heat Loss Data, kW

Model	Standard Unit	With Hood	Hood and Insulation
LRW 18-2E thru 18-2G	10	10	7
LRW 18-3F thru 18-3G	13	10	7
LRW 18-4F thru 18-4G	16	11	7
LRW 18-5G thru 18-5H	18	12	8
LRW 30-2G thru 30-2H	15	13	9
LRW 30-3G thru 30-3H	21	13	9
LRW 30-4H	26	14	9
LRW 30-5H	29	16	10
LRW 45-3I thru 45-3J	32	17	11
LRW 45-4J	39	19	12
LRW 45-5J	44	20	13
LRW 45-6J	47	22	14
LRW 60-3K thru 60-3L	43	22	14
LRW 60-4K thru 60-4L	52	23	15
LRW 60-5L thru 60-5M	59	25	16
LRW 60-6M	62	27	17
LRW 72-3K thru 72-3L	50	23	14
LRW 72-4K thru 72-4L	60	24	16
LRW 72-5L	68	26	17
LRW 96-4L thru 96-4N	81	29	19
LRW 96-5M thru 96-5N	91	31	20
LRW 96-6N	97	34	21

### Tapered Discharge Hood Dimensions

Model	L (mm)	H (mm)	W (mm)	W1 (mm)	Weight (kgs)	Number of Hoods
LRW 18	1823	745	1029	542	176	1
LRW 30	1823	1120	1540	788	255	1
LRW 45	2724	1120	1540	788	350	1
LRW 60	3648	1120	1540	788	430	1
LRW 72	2724	1205	2388	1207	525	1
LRW 96	3648	1205	2388	1207	683	1

### Straight-Sided Discharge Hood Dimensions

Model	L (mm)	H (mm)	W (mm)	Weight (kgs)	Number of Hoods
LRW 18	1823	780	1029	210	1
LRW 30	1823	780	1540	275	1
LRW 45	2724	780	1540	370	1
LRW 60	3648	780	1540	470	1
LRW 72	2724	780	2388	500	1
LRW 96	3648	780	2388	630	1

### Discharge Hood Dimensions

UNIT No.	L (mm)	H (mm)	W (mm)	W1 (mm)	Weight (kgs)	No. of Hoods
LSWA 20	1805	965	1130	590	170	1
LSWA 30	2700	965	1130	590	230	1
LSWA 41	3623	965	1130	590	275	1
LSWA 58	3623	1130	1550	785	305	1
LSWA 87	5465	1130	1550	785	450	1
LSWA 91	3626	1210	2370	1205	370	1
LSWA 116	3626	1410	2975	1522	475	1
LSWA 135	5466	1210	2370	1205	530	1
LSWA 174	5466	1410	2975	1522	660	1
LSWA 182	3626	1210	2370	1205	370	2
LSWA 232	3626	1410	2975	1522	475	2
LSWA 270	5466	1210	2370	1205	530	2
LSWA 348	5466	1410	2975	1522	660	2
PMWA 116	3626	955	2975	-	680	1
PMWA 174	5466	955	2975	-	970	1
PMWA 232	3626	955	2975	-	680	2
PMWA 348	5466	955	2975	-	970	2

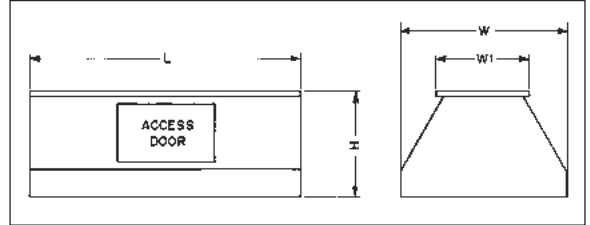

**CENTRIFUGAL FAN MODELS**

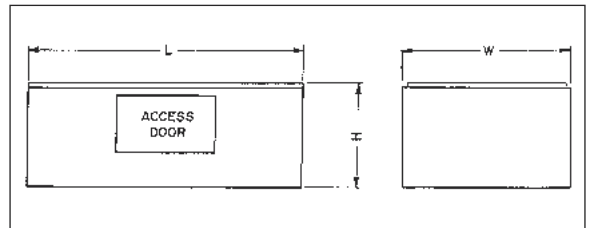

**POWER-MIZER MODELS**

### Heat Loss Data, KW

CENTRIFUGAL FAN MODELS								POWER-MIZER MODELS			
Unit No.	Std. Unit	With Hood	Hood and Insulation	Unit No.	Std. Unit	With Hood	Hood and Insulation	Unit No.	Std. Unit	With Hood	Hood and Insulation
LSWA- 20AA	11	8	6	LSWA- 174A	130	42	27	PMWA- 116A	99	37	23
20A	15	10	6	174B	158	45	29	116B	120	40	25
20B	18	11	7	174C	177	48	31	116C	135	42	27
20C	20	11	7	174D	189	51	33	116D	143	45	29
LSWA- 30A	22	13	8	LSWA- 182A	133	57	37	PMWA- 174A	150	48	31
30B	27	14	9	182B	162	62	39	174B	182	52	33
30C	30	15	10	182C	181	66	42	174C	204	55	35
LSWA- 41A	30	16	10	182D	193	70	45	174D	217	59	38
41B	36	18	11	LSWA- 232A	172	64	41	PMWA- 232A	198	73	47
41C	41	19	12	232B	209	69	44	232B	240	79	50
LSWA- 58A	43	21	13	232C	234	74	47	232C	269	84	54
58B	52	23	14	232D	249	78	50	232D	287	90	58
58C	59	24	16	LSWA- 270A	202	77	50	PMWA- 348A	300	96	62
58D	62	26	17	270B	244	83	53	348B	363	103	66
LSWA- 87A	65	28	18	270C	274	88	56	348C	408	110	71
87B	79	31	20	270D	242	93	60	348D	434	118	75
87C	89	33	21	LSWA- 348A	255	84	53				
87D	94	36	23	348B	316	90	57				
LSWA- 91A	67	29	18	348C	355	96	62				
91B	81	31	20	348D	378	102	65				
91C	91	33	21								
91D	96	35	22								
LSWA- 116A	80	32	20								
116B	104	34	22								
116C	117	37	23								
116D	125	39	25								
LSWA- 135A	101	39	25								
135B	122	41	26								
135C	137	44	28								
135D	146	47	30								



# Steel Support

The recommended support for EVAPCO coolers is structural “I” beams located under the outer flanges and running the entire length of the unit. Mounting holes, 19 mm in diameter are located in the bottom channels of the pan section to provide for bolting to the structural steel. (Refer to certified drawings from the factory for bolt hole locations.)

Beams should be level to within 3 mm per 2 m before setting the unit in place. Do not level the unit by shimming between it and the “I” beams as this will not provide proper longitudinal support.

**Plan Views**

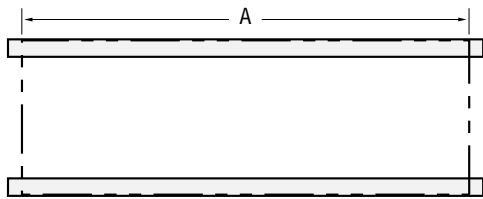

**End Elevations**

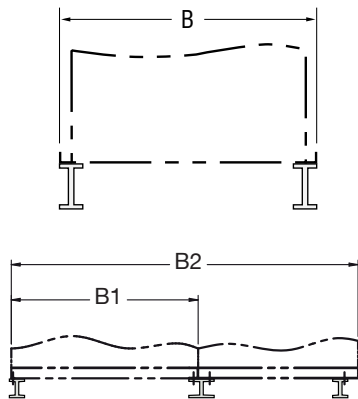

LRW DIMENSIONS			
Models		A	B
LRW	18-2E to 18-5H	3083	1029
	30-2G to 30-5H	3731	1540
	45-3I to 45-6J	4636	1540
	60-3K to 60-6M	5553	1540
	72-3K to 72-5L	4629	2388
	96-4L to 96-6N	5553	2388

LSWA DIMENSIONS					
			Compact	Basic	Extended
Box size	A	B1	B2	B2	B2
4x6	1826	1235	2378	2648	3048
4x9	2724	1235	2378	2648	3048
4x12	3645	1235	2378	2648	3048
4x18	5486	1235	2378	2648	3048
5x12	3645	1651	2794	3064	3453
5x18	5483	1651	2794	3064	3453
8x12	3651	2388	3531	3800	4188
8x18	5486	2388	3531	3800	4188
8x24	7341	2388	3531	3800	4188
8x36	11011	2388	3531	3800	4188
10x12	3651	2991	4134	4404	4791
10x18	5493	2991	4134	4404	4791
10x24	7344	2991	4134	4404	4791
10x36	11027	2991	4134	4404	4791

PMWA DIMENSIONS			
Models		A	B
PMWA	116A to 116D	3648	2991
	174A to 174D	5493	2991
	232A to 232D	7334	2991
	348A to 348D	11024	2991

# Application

## Piping

Unit piping should be designed and installed in accordance with generally accepted engineering practice. The piping layout should be symmetrical on multiple unit systems, and sized for a reasonably low water velocity and pressure drop.

The closed circuit cooler is recommended only on a closed, pressurized system. The piping system should include an expansion tank to allow for fluid expansion and purging air from the system.

**Note: Closed Circuit Coolers should never be used on an open type system. An open type system with a cooler may result in premature coil failure.**

The piping system should be designed to permit complete drainage of the heat exchanger coil. This will require a vacuum breaker or air vent to be installed at the high point and a drain valve installed at the low point of the piping system. Both must be adequately sized.

All piping should be securely anchored by properly designed hangers and supports. No external loads should be placed upon the cooler connections, nor should any of the pipe supports be anchored to the cooler framework.

## Freeze-Up Protection

If the units are installed in a cold climate and operated year-round, freeze-up protection must be provided for the heat exchanger coil in the unit as well as for the recirculating water system.

## Recirculating Water System

The simplest and most foolproof method of protecting the recirculating water system from freeze-up is through the use of a remote sump located inside the building below the unit. The recirculating water pump is mounted at the remote sump and whenever it is shut off, all of the water in the cooler drains back to the warm inside sump. The Engineering Data Tables presented on pages 14 thru 19 provide information to size the remote sump tank.

If a remote sump cannot be used, pan heaters are available, either steam, hot water, or electric type, to keep the pan water from freezing when the unit is shut down. Water lines to and from the unit, the pump and pump piping up to the overflow connection must also be wrapped with electric heating cable and insulated to protect them from freeze-up. The cooler cannot be operated dry (fans on, pump off) with this method unless water is completely drained from the pan. The pan heaters are sized to prevent pan water from freezing when the unit is shut down, but they are not sufficient to prevent freeze-up in a cooler operating dry.

## Heat Exchanger Coil

The simplest and most foolproof method of protecting the heat exchanger coil from freeze-up is to use an ethylene glycol solution. If this is not possible, an auxiliary heat load must be maintained on the coil at all times so that the water temperature does not drop below 10°C when the cooler is shut down. Also, a minimum recommended flow rate must be maintained. Refer to pages 22-23 for heat loss data.

When the unit is operating during freezing weather, some type of capacity control is normally required in order to keep water temperatures from dropping below 10°C. Operating dry with a remote sump is an excellent way to reduce unit capacity at low temperatures (this is covered under recirculating water freeze-up protection). Other methods that can be used are modulating fan dampers, fan cycling or two-speed motors. These can be used individually or in combination with dry operation. Which method will depend upon the particular application, and EVAPCO engineers are available for recommendations.

If an anti-freeze solution is not used, the coil must also be drained immediately whenever the pump is shut down or flow stops. This can be accomplished by automatic drain valves and air vents in the piping to and from the cooler. Care must be taken to ensure that the piping is adequately insulated and sized to allow the water to flow quickly from the coil. This method of freeze control should only be used in an emergency situation. Coils should not be drained for an extended period of time. The amount of ethylene glycol required for a system will depend upon the total volume of water in the closed loop and the winter ambient conditions for the installation. The Engineering Data Tables presented on pages 14 thru 19 provide the amount of water contained inside the cooler coils to assist in this calculation.

Unit No.		Minimum Flow (l/s)
LSWA / PMWA	20, 30, 41	3,8
	58, 87	4,7
	91, 135	8,8
	182, 270	17,6
	116, 174	9,5
	232, 348	19,0
LRW	18	3,3
	30, 45 and 60	4,7
	72 and 96	8,8

## Principle of Operation

The process fluid is circulated through the coil of the closed circuit cooler. Heat from the process fluid is dissipated through the coil tubes to the water cascading downward over the tubes. Simultaneously, air is blown through by the fans at the base of the cooler and travels upward through the coil opposite the water flow. A small portion of the water is evaporated which removes the heat. The warm moist air is blown to the top of the closed circuit cooler by the fans and discharged to the atmosphere. The remaining water falls to the sump at the bottom of the cooler and is recirculated by the pump to the water distribution system and back over the coils.

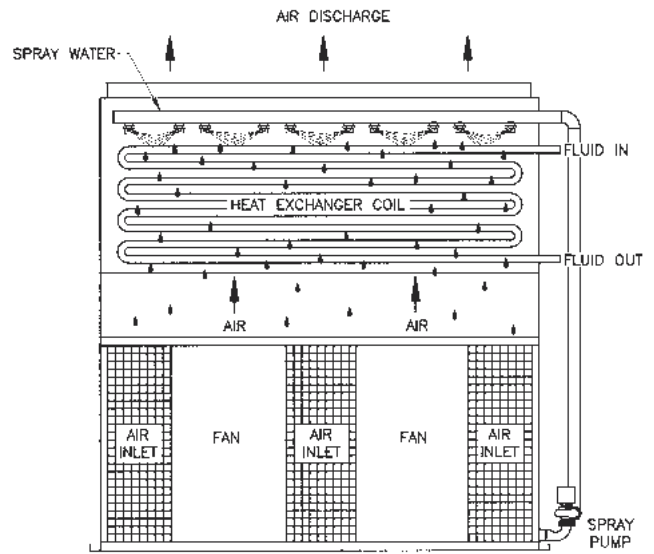

## Principle of Operation

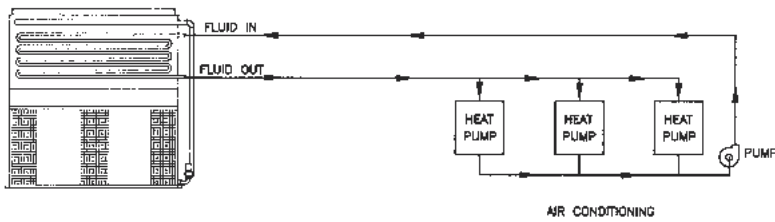

### Air Conditioning

- Unitary Heat Pump Systems
- Computer Room Cooling
- Refrigeration Supplement

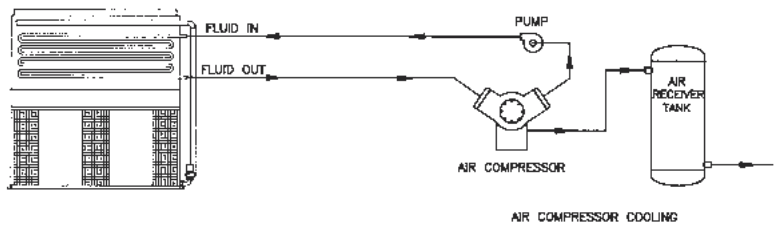

### Manufacturing

- Air Compressors
- Plastic Mold Machines
- Transformers
- Engines

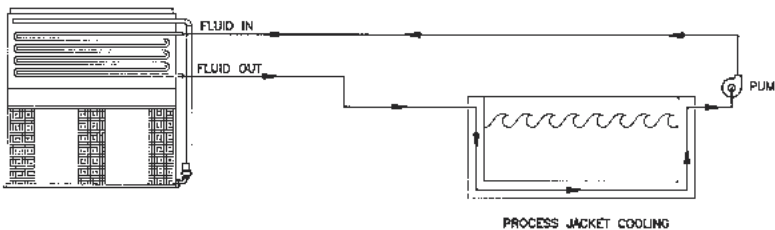

### Steel Mills & Foundries

- Quench Tanks
- Rolling Mills
- Induction Furnaces
- Continuous Casters

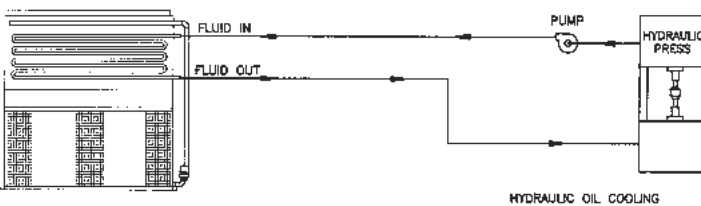

### Industrial Fluids

- Hydraulic Oils
- Plating Solutions
- Quench Oils



# Closed Circuit Coolers Specifications

Furnish and install as shown on the plan an EVAPCO Model \_\_\_\_\_ Closed Circuit Cooler. Each unit shall have the capacity to cool \_\_\_\_\_ of \_\_\_\_\_ from \_\_\_\_\_ to \_\_\_\_\_ with a \_\_\_\_\_ entering wet bulb temperature. Unit height shall not exceed \_\_\_\_\_.

## Casing and Fan Section

The casing and fan section shall be constructed of Z-725 galvanized steel for long life and durability. Fan section shall include fans, motors and drives. The entire drive system (including fans, motors, pulleys and belts) shall be located in the dry entering airstream.

## Cold Water Basin *(only for LRW)*

**The complete cold water basin shall be constructed of Type 304 stainless steel for long life and durability.**

Standard cold water basin accessories shall include Type 304 stainless steel overflow, drain, anti-vortexing hood, strainers and brass make-up valve with unsinkable, foam filled plastic float. A circular access door shall be located above the basin to allow easy access to the pan interior.

The outlet shall be Type 304 stainless steel beveled for welding or a threaded connection.

## Model LSWA & LRW - Centrifugal Fans/Drives

Fans shall be forwardly curved centrifugal type of hot-dip galvanized construction. The fans shall be factory installed into the pan-fan section, and statically and dynamically balanced for vibration free operation. Fans shall be mounted on either a solid steel shaft or a hollow steel shaft with forged bearing journals. The fan shaft shall be supported by heavy-duty, self-aligning bearings with cast-iron housings and lubrication provided fittings for maintenance.

The fan drive shall be V-belt type with taper lock pulleys designed for 150% of the motor nameplate kW. Drives are to be mounted and aligned at the factory.

## Model PMWA - Power-Mizer Fans/Drives

Fans shall be vane-axial type constructed of cast aluminum alloy blades. They shall be arranged in a two-stage system installed in a closely fitted cowl with venturi air inlet and air stabilizing vanes. Fan shaft bearings shall be heavy-duty self aligning ball type with grease fittings extended to the outside of the unit.

The fan drive shall be solid backed Power-Band constructed of neoprene with polyester cords and designed for 150% of motor nameplate kW. Drives are to be mounted and aligned at the factory.

## Fan Motor

Fan motor(s) shall be \_\_\_\_\_ kW T.E.F.C. suitable for outdoor installation on \_\_\_\_\_ volts, \_\_\_\_\_ hertz, and \_\_\_\_\_ phase electrical service. Motor(s) shall be mounted on an adjustable base.

## Heat Transfer Coil

The coil(s) shall be all prime surface steel, encased in steel framework with the entire assembly hot-dip galvanized after fabrication. Coil(s) shall be designed with sloping tubes for free drainage of liquid and air pressure tested under water in accordance with the "Pressure Equipment Directive" (PED) 97/23/EC.

## Water Recirculation Pump

The pump shall be a close-coupled, centrifugal type with a mechanical seal. Pump motor shall be \_\_\_\_\_ kW T.E.F.C. design suitable for outdoor installation on \_\_\_\_\_ volts, \_\_\_\_\_ hertz, and \_\_\_\_\_ phase electrical service.

## Water Distribution System

The system shall provide a water flow rate of not less than 4 l/s over each square meter of unit face area to ensure proper flooding of the coil. The spray header shall be constructed of polyvinyl chloride pipe for corrosion resistance. All spray branches shall be removable and include a threaded end plug for cleaning. The water shall be distributed over the entire coil surface by precision molded from heavy-duty, glass reinforced nylon spray nozzles for long life and 100% corrosion resistance (34 mm diameter orifice and 38 mm clearance between the nozzle bottom and water diverter plate) with an internal sludge ring to eliminate clogging. Nozzles shall be threaded into the spray header to provide easy removal for maintenance.

## Eliminators

The eliminators shall be constructed of inert polyvinyl chloride that has been specially treated to resist UV degradation. Assembled in easily handled sections, the eliminators shall incorporate three changes in air direction to assure removal of entrained moisture from the discharge airstream. The maximum drift rate shall not exceed 0.001% of the recirculated water rate.

## Finish

The casing and fan section shall be constructed of Z-725 heavy gauge mill hot-dip galvanized steel. During fabrication, all panel edges shall be coated with a 95% pure zinc compound.



World Headquarters /  
Research and  
Development Center

EVAPCO Manufacturing  
Facilities

## EVAPCO, Inc. - World Headquarters & Research / Development Center

P.O. Box 1300 • Westminister, MD 21158 USA  
Ph: +1 410-756-2600 • Fx: +1 410-756-6450 • [marketing@evapco.com](mailto:marketing@evapco.com)

### North America

**EVAPCO, Inc.**  
**World Headquarters**  
P.O. Box 1300  
Westminster, MD 21158 USA  
Ph: 410-756-2600 - Fx: 410-756-6450  
[marketing@evapco.com](mailto:marketing@evapco.com)

**EVAPCO East**  
5151 Allendale Lane  
Taneytown, MD 21787 USA  
Ph: 410-756-2600 - Fx: 410-756-6450  
[marketing@evapco.com](mailto:marketing@evapco.com)

**EVAPCO Midwest**  
1723 York Road  
Greenup, IL 62428 USA  
Ph: 217-923-3431 - Fx: 217-923-3300  
[evapcomw@evapcomw.com](mailto:evapcomw@evapcomw.com)

**EVAPCO West**  
1900 West Almond Avenue  
Madera, CA 93637 USA  
Ph: 559-673-2207 - Fx: 559-673-2378  
[contact@evapcowest.com](mailto:contact@evapcowest.com)

**EVAPCO Iowa**  
925 Quality Drive  
Lake View, IA 51450 USA  
Ph: 712-657-3223 - Fx: 712-657-3226

**EVAPCO Iowa  
Sales & Engineering**  
215 1st Street, NE  
P.O. Box 88  
Medford, MN 55049 USA  
Ph: 507-446-8005 - Fx: 507-446-8239  
[evapcomn@evapcomn.com](mailto:evapcomn@evapcomn.com)

**EVAPCO Newton**  
701 East Jourdan Street  
Newton, IL 62448 USA  
Ph: 618-783-3433 - Fx: 618-783-3499  
[evapcomw@evapcomw.com](mailto:evapcomw@evapcomw.com)

**EVAPCOLD**  
521 Evapco Drive  
Greenup, IL 62428 USA  
Ph: 217-923-3431  
[evapcomw@evapcomw.com](mailto:evapcomw@evapcomw.com)

**EVAPCO-Dry Cooling, Inc.**  
981 US Highway 22 West  
Bridgewater, NJ 08807 USA  
Ph: 1-908-379-2665  
[info@evapco-blct.com](mailto:info@evapco-blct.com)

**Refrigeration Valves &  
Systems Corporation**  
*A wholly owned subsidiary of EVAPCO, Inc.*  
1520 Crosswind Dr.  
Bryan, TX 77808 USA  
Ph: 979-778-0095 - Fx: 979-778-0030  
[rvs@rvscorp.com](mailto:rvs@rvscorp.com)

**Evapco Northwest**  
5775 S.W. Jean Road, Suite 104  
Lake Oswego, OR 97035 USA  
Ph: 503-639-2137 - Fx: 503-639-1800

**EvapTech, Inc.**  
*A wholly owned subsidiary of EVAPCO, Inc.*  
8331 Nieman Road  
Lenexa, KS 66214 USA  
Ph: 913-322-5165 - Fx: 913-322-5166  
[marketing@evaptechinc.com](mailto:marketing@evaptechinc.com)

**Tower Components, Inc.**  
*A wholly owned subsidiary of EVAPCO, Inc.*  
5960 US HWY 64E  
Ramseur, NC 27316  
Ph: 336-824-2102 - Fx: 336-824-2190  
[mail@towercomponentsinc.com](mailto:mail@towercomponentsinc.com)

### South America

**Evapco Brasil  
Equipamentos Industriais Ltda**  
Rua Alexandre Dumas 1601  
04717-004 Sao Paulo - SP - Brazil  
Ph: (55) 11-5184-0067

### Europe

**EVAPCO Europe BVBA  
European Headquarters**  
Heersterveldweg 19, Industrieterrein Oost  
3700 Tongeren, Belgium  
Ph: (32) 12-395029 - Fx: (32) 12-238527  
[evapco.europe@evapco.be](mailto:evapco.europe@evapco.be)

**EVAPCO Europe, S.r.l.**  
Via Ciro Menotti 10  
I-20017 Passirana di Rho, Milan, Italy  
Ph: (39) 02-939-9041 - Fx: (39) 02-935-00840  
[evapcoeuropa@evapco.it](mailto:evapcoeuropa@evapco.it)

**EVAPCO Europe, S.r.l.**  
Via Dosso 2 - 23020 Piateda Sondrio, Italy

**EVAPCO Europe, GmbH**  
Insterburger Straße, 18  
D-40670 Meerbusch, Germany  
Ph: (49) 2159-69560 - Fx: (49) 2159-695611  
[info@evapco.de](mailto:info@evapco.de)

**EVAPCO Middle East DMCC**  
Reef Tower, 29th Level, Cluster O,  
Jumeirah Lake Towers, P.O. Box 5003310  
Dubai, United Arab Emirates  
Ph: (971) 4448-7242 - Fx: (971) 4448-7112  
[info@evapco.ae](mailto:info@evapco.ae)

**EVAPCO Air Solutions a/s**  
*A wholly owned subsidiary of EVAPCO, Inc.*  
Knøsgårdvej 115, 9440 Aabybro, Denmark  
Ph: (45) 9824-4999 - Fx: (45) 9824-4990  
[flexcoil@flexcoil.dk](mailto:flexcoil@flexcoil.dk)

**EVAPCO S.A. (Pty.) Ltd.**  
*A licensed manufacturer of Evapco, Inc.*  
18 Quality Rd, Isando 1600, Rep. of S. Africa  
Ph: (27) 11 392-6630 - Fx: (27) 11-392-6615  
[evapco@evapco.co.za](mailto:evapco@evapco.co.za)

**Evap Egypt Engineering Industries Co.**  
*A licensed manufacturer of Evapco, Inc.*  
5 Al Nasr Road St., Nasr City, Cairo, Egypt  
Ph: (20) 2-24022866 / (20) 2-24044978  
Fx: (20) 2-404-4667 / Mob: (20) 12-3917979  
[primacool@link.net](mailto:primacool@link.net) / [shady@primacool.net](mailto:shady@primacool.net)

### Asia/Pacific

**EVAPCO China  
Asia/Pacific Headquarters**  
1159 Luoning Rd., Baoshan Industrial Zone  
Shanghai, P. R. China, Postal Code: 200949  
Ph: (86) 21-6687-7786 - Fx: (86) 21-6687-7008  
[marketing@evapcochina.com](mailto:marketing@evapcochina.com)

**Evapco (Shanghai) Refrigeration  
Equipment Co., Ltd.**  
1159 Luoning Rd., Baoshan Industrial Zone  
Shanghai, P.R. China, Postal Code: 200949  
Ph: (86) 21-6687-7786 - Fx: (86) 21-6687-7008  
[marketing@evapcochina.com](mailto:marketing@evapcochina.com)

**Beijing EVAPCO Refrigeration  
Equipment Co., Ltd.**  
Yan Qi Industrial Development District  
Huai Rou County  
Beijing, P.R. China, Postal Code: 101407  
Ph: (86) 10 6166-7238 - Fx: (86) 10 6166-7395  
[evapcoobj@evapcochina.com](mailto:evapcoobj@evapcochina.com)

**EVAPCO Australia Pty Ltd.**  
34-42 Melbourne Road - P.O. Box 436  
Riverstone, N.S.W. Australia 2765  
Ph: (61) 29 627-3322 - Fx: (61) 29 627-1715  
[sales@evapco.com.au](mailto:sales@evapco.com.au)

**EvapTech Composites Sdn. Bhd**  
No. 70 (Lot 1289) Jalan Industri 2/3  
Rawang Integrated Industrial Park  
Rawang, Selangor, 48000 Malaysia  
Ph: 60 3 6092-2209 - Fx: 60 3 6092-2210

**EvapTech Asia Pacific Sdn. Bhd**  
*A wholly owned subsidiary of EvapTech, Inc.*  
IOI Business Park, 2/F Unit 20  
Persiaran Puchong Jaya Selatan  
Bandar Puchong Jaya,  
47170 Puchong, Selangor, Malaysia  
Ph: +(60-3) 8070 7255 - Fx: +(60-3) 8070 5731  
[marketing-ap@evaptech.com](mailto:marketing-ap@evaptech.com)



**EVAPCO... Specialists in Heat Transfer Products and Services.**  
Visit EVAPCO's Websites at: [www.evapco.eu](http://www.evapco.eu) / [www.mrgoodtower.eu](http://www.mrgoodtower.eu)

